

Float switch

Float switch with switches magnetically operated single or multiple Reed switches, including bistable types
PN16 to PN64
Threaded connection from 2", Flange connection from DN50/ANSI 2"
All parts in contact with media are hermetically welded on demand

Product group **719**

Type **0021**

Sheet: 1/2 Revision: 5

Date: 04/16

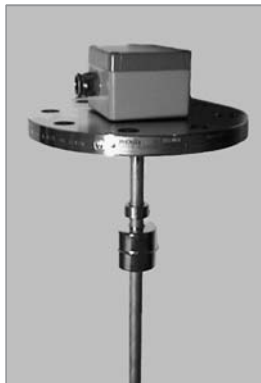

Version:
flange
cylinder float

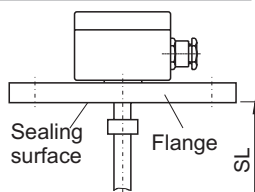

measures in mm

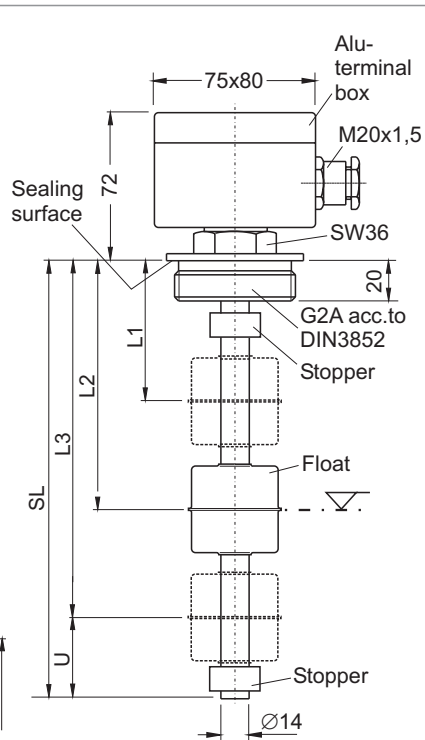

Flanges and seal welding are accessories

Field of application

The Float switch Type 719.0021 is for signalling liquid level limits. It has to be mounted from the top into tanks. Depending on the float design (1.4571, Titanium, ...) a broad range of process data can be achieved.

General Data

Accuracy: ±5 mm
Switch points position: fix or adjustable (optional)
Hysteresis: 10 mm
Elevation from vertical position: 30°
L1 min: 42 mm
Insertion length SL: from 150 to 5800 mm
Connection: as standard G2A, other see ordering key
Flanges are accessories
Terminal box: Alu, 75x80x57 mm
Weight: G2A: 0,9 kg + 7 g/cm

Design Data

Pressure: see float table, max. 6,4 MPa
Temperature of housing: -60 to +90 °C
Operating temperature: -75 to +125 °C
Density: >0,45...>0,80 g/cm³
Materials in contact with media: 1.4571
other materials on request

Electrical Data

Switch voltage: 230 VDC/230 VAC
Switch current: 1.0 A
Rapt. capacity: 30 W/30 VA
Contact function: NC, NO, SPDT potential free
Wire cross section: max. 2,5 mm²
Cable gland: M20x1,5 (for Ex i in zone 1 and 2 blue)
Ingress protection EN 60529: IP 67

Float table

Shape	Density [g/cm ³]	Press. [MPa]	Dimension HxDxD [mm]	U [mm]	Material
Cylinder	≥ 0,70	1,6	43x43x15,5	50	1.4571
Sphere	≥ 0,60	2,5	52x52x15,5	60	1.4571
Sphere	≥ 0,80	4,0	52x52x15,5	60	1.4571
Cylinder	0,45...0,60	2,5...6,4	156x56x16	165	3.7025

Floats for lower density, higher pressure and interface detection on request

Electrical wiring hints

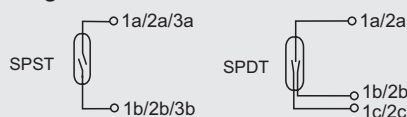

Certificates

May be connected to intrinsic safe circuits and may be operated in zone 1 and zone 2. Referring to EN50020 chapter 5.4 no Ex-Certification is needed.

Subject to alterations

Ordering no.

Ordering no.	Contact 1.	Contact 2.	Contact 3.	Sensor length SL in mm
719.0021 - XXXXX - XXXX	X	X	X	X
Special	9	9	9	
Switch NC monostable	N	N	N	
Switch NC bistable	O	O	O	
PT-100	P	P	P	
Switch NO monostable	R	R	R	
Switch NO bistable	S	S	S	
Thermo switch	T	T	T	
SPDT monostable	V	V	V	S
SPDT bistable	W	W	W	E
				F Fixed
				V adjustably
				1 G1/2A (if flange)
				2 G1 1/2A
				3 G2A
				4 1.4571
				Standard
				Ex i (cable gland blue)

Phoenix Control Kft.

**Bolyki Tamas street 44.
Ozd, 3600, Hungary
Tel.: +36-48-572-310
+36-48-572-567
Fax.: +36-48-471-642
e-mail: info@phoenix-brv.hu
web: www.phoenix-brv.hu**

Float switch

Application hints, spare parts

Product group **719**

Type **0021**

Sheet: 2/2 Revision: 5

Date: 04/16

Thread connection

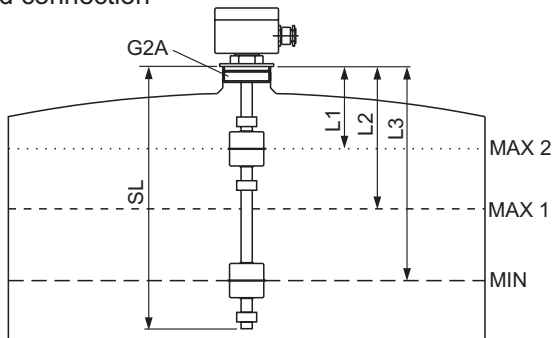

Flange connection

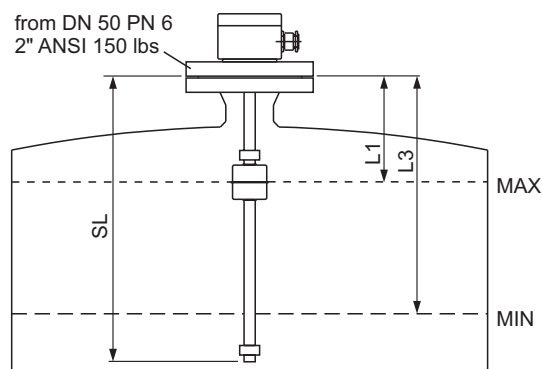

Installation hints

Threaded connection

Top mounted into a tank with a 2" threaded connection. Equipped with 3 contacts and two floats for signalling 3 levels MIN, MAX1 and MAX2.

For passing through the float it is recommended that thread at least G2A, see also float table. SL equals dimension is length measured from sealing surface

Flange connection

Top mounted into a tank with flange. Equipped with 2 contacts and one float for signalling 2 levels MIN and MAX. For passing through the float it is recommended that flange is at least DN50/2" ANSI, see also float table. SL equals insertion length measured from sealing surface flange.

Electrical hints, contact protection recommendations

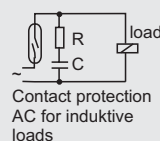
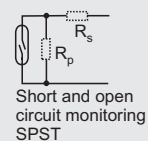

U[VAC]	I [A]	R[kΩ]	C [μF]
230	1	18	0,1
120	1	8,2	0,1
48	1	3,3	0,1
24	1	0,5	0,1

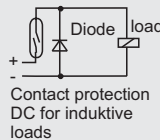
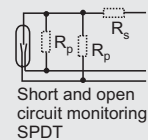

Details see TK-210

Connection diagrams

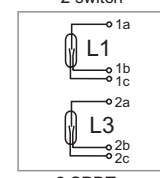
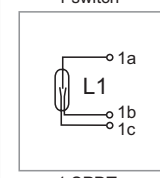
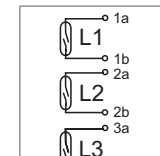
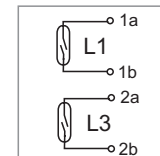
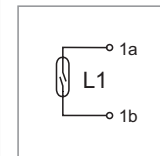

For more than 3 switches/2 SPDT plugs are used for connection. Switches can be either N.O., N.C., monostable or bistable.

Contact function refers to rising level of liquid.

Subject to alterations

Spare parts

Float table

Shape	Density[g/cm ³]	Pressure [Mpa]	Material	Dimension HxDxD [mm]	Ordering-no.
Cylinder	≥ 0,70	1,6	1.4571	43x43x15,5	SZ0431504444
Spherel	≥ 0,60	2,5	1.4571	52x52x15,5	SK0521505354
Sphere	≥ 0,80	4,0	1.4571	52x52x15,5	SK0521505254
Cylinder	0,45...0,60	2,5...6,4	3.7025	156x56x16	SZ1561605664

Denomination	Ordering-no.
Stopper 12x25x14	D007052142

Phönix Control Kft.

**Bolyki Tamas street 44.
Ozd, 3600, Hungary
Tel.: +36-48-572-310
+36-48-572-567
Fax.: +36-48-471-642
e-mail: info@phoenix-brv.hu
web: www.phoenix-brv.hu**